



INSTALLATION INSTRUCTIONS

Accessory
CARGO NET
P/N 08L96-TZ5-200

Application
2015 MDX

Publications No.
BII 51627
Issue Date
MAY 2015

PARTS LIST

Cargo net

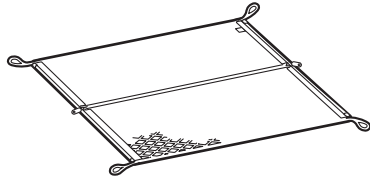

4 Snaps

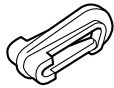

2 Anchors



2 Bolts



TOOLS AND SUPPLIES REQUIRED

Drill

8 mm and 14 mm Drill bits

Tape

File

Ruler

Eye protection (face shield, safety goggles, etc.)

INSTALLATION

Client Information: The information in this installation instruction is intended for use only by skilled technicians who have the proper tools, equipment, and training to correctly and safely add equipment to your vehicle. These procedures should not be attempted by "do-it-yourselfers."

NOTE: Be careful not to damage the body.

1. Pull each lever, and fold down the left and right third row seats.

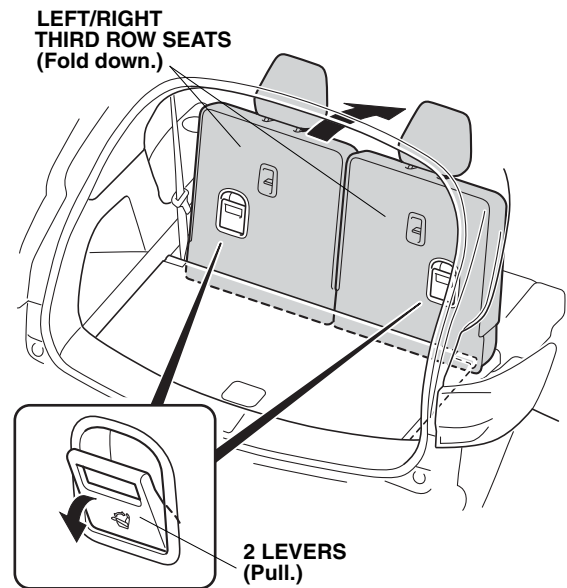

QB01910AH

- At the rear of the left rear side trim panel, use your finger to locate the pre-drilled hole in the panel under the carpet.

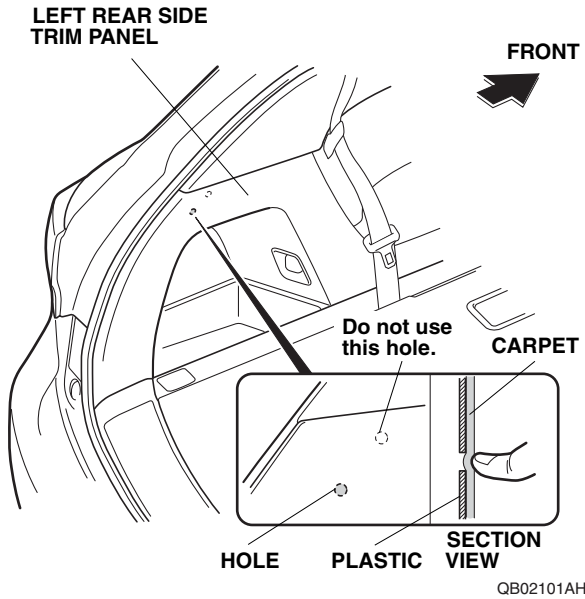

- While wearing eye protection, drill a 14 mm hole in the left rear side trim panel:
 - Wrap tape around an 8 mm and a 14 mm drill bits, 10 mm (0.4 in.) away from the tip, or use a drill stop.
 - First drill with an 8 mm drill bit, and finish with a 14 mm drill bit.
 - Remove any burrs.

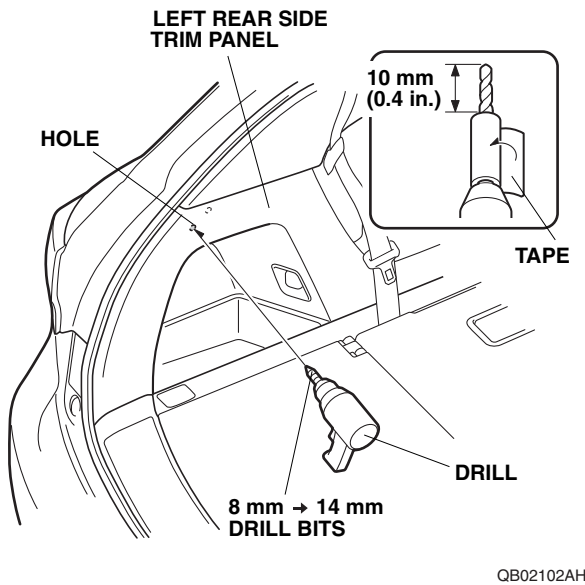

- Thread one bolt into one anchor.

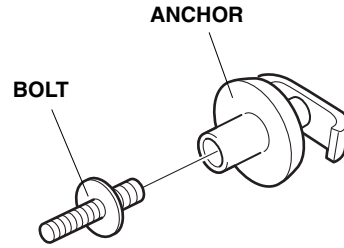

QB02103AH

- Thread the anchor into the 14 mm hole you drilled. Adjust the anchor to the horizontal position.

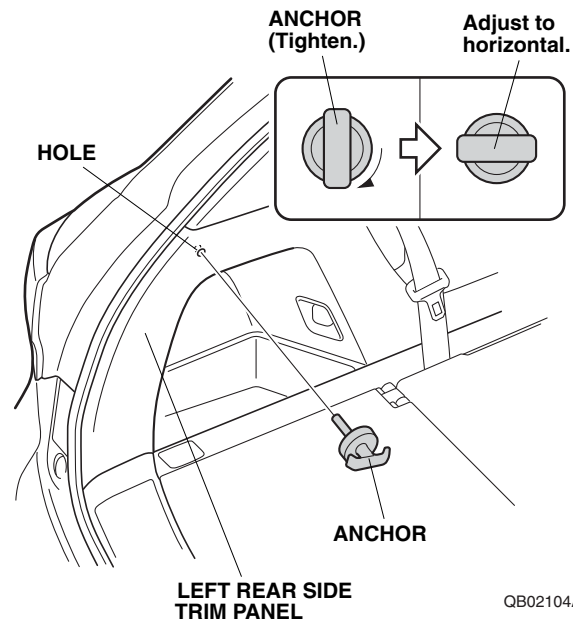

- Repeat steps 2 through 5 to install an anchor on the right side of the vehicle.

Installing the Cargo Net

The cargo net can be installed in two positions.

Horizontal Position:

- Attach four snaps to the cargo net at the loops shown.

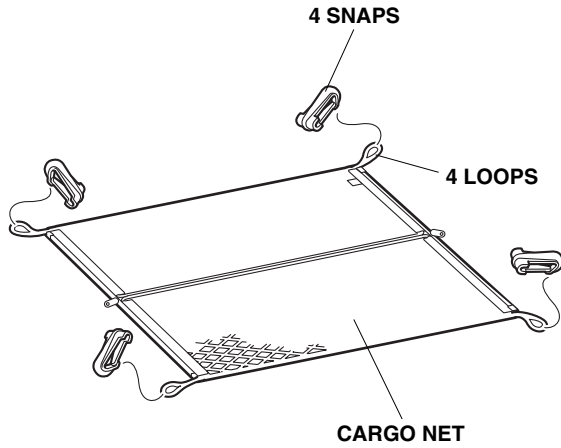

700106AE

- Attach four snaps from the cargo net to the cargo hooks shown.

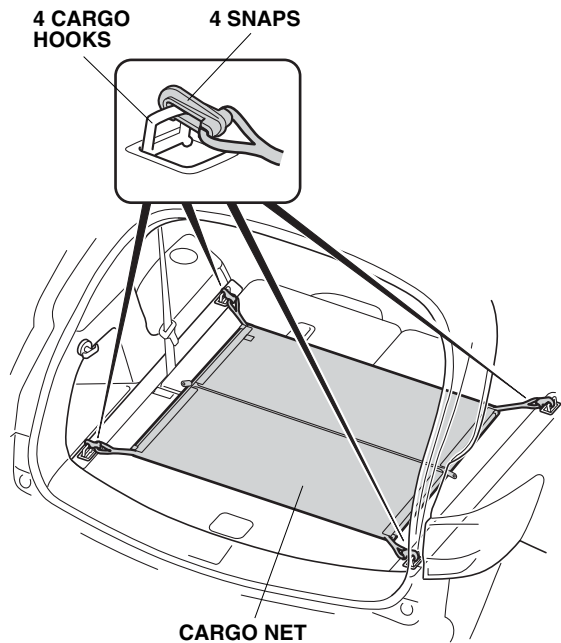

QB02105AH

Vertical Position:

- Fold the cargo net in half, and zip up the zipper on each side. Attach two snaps to the cargo net at the loops shown.

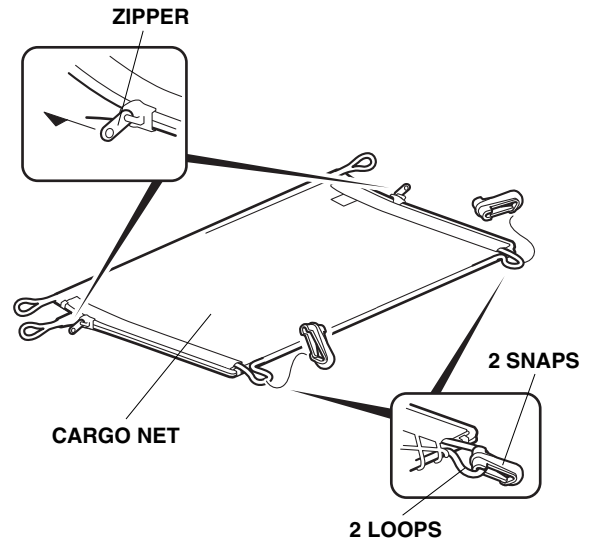

QBD2525AH

- Attach four loops from the cargo net to the two anchors. Attach two snaps from the cargo net to two cargo hooks.

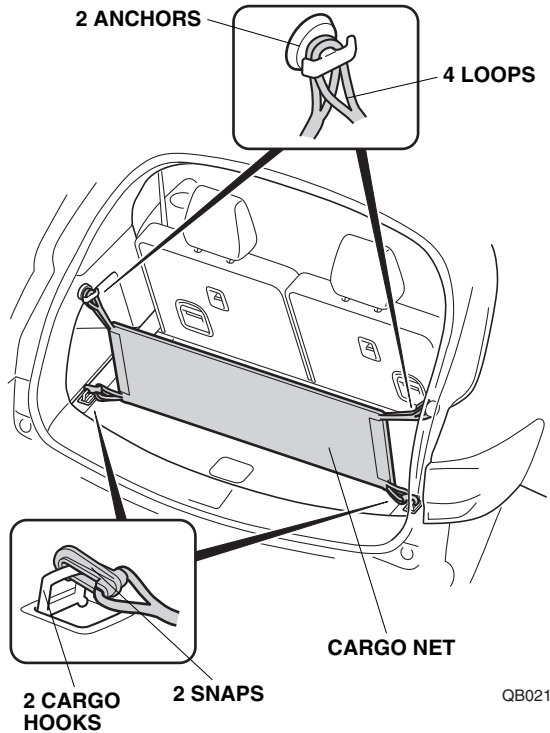

QB02106BH